



噴流式空氣輸送器

JETFLOW AIR MOVER

防爆通風
VENTILATION OF
EXPLOSION PROOF

強勁輕便
POWERFUL
(LIGHTWEIGHT)

堅固耐用
DURABLE



MX-3L
MX-6L



MX-2S

MX-3S

PAT. P. NO. 83309324



噴流式空氣輸送器 JETFLOW AIR MOVER

JOUNING

功能特性

- 1 出風口最高風速可達每秒40米，重量輕又耐用，不易生鏽。
- 2 採用鋁合金噴氣座及不銹鋼風管。
- 3 具有防爆之功能，可安心使用，在有易燃氣體及易塵爆之場所，本機無馬達、扇葉、電器開關引爆之顧慮。
- 4 操作簡單，無故障，風量可隨意調整。

FEATURES

- 1 MAXIMUM CAPACITY OUTPUT SUCTION REACHES 40M/SEC, DURABLE, LIGHT WEIGHT AND RUST FREE DESIGNS.
- 2 ALUM ALLOY NOZZLE BASE AND STAINLESS DUCT
- 3 EXPLOSION PROOF DEVICE THAT YOU CAN RELY ON THERE IS NO RISK OF EXPLOSIONS AND INFLAMMABLE FUME ON MOTOR, BLADES OR ELECTRIC SWITCH IN THE EXPLOSIVE FIELDS.
4. EASY OPERATION, DEFECTIVE FREE AND ADJUSTABLE AIR FLOW

30 倍出風量
TIMES CAPACITY

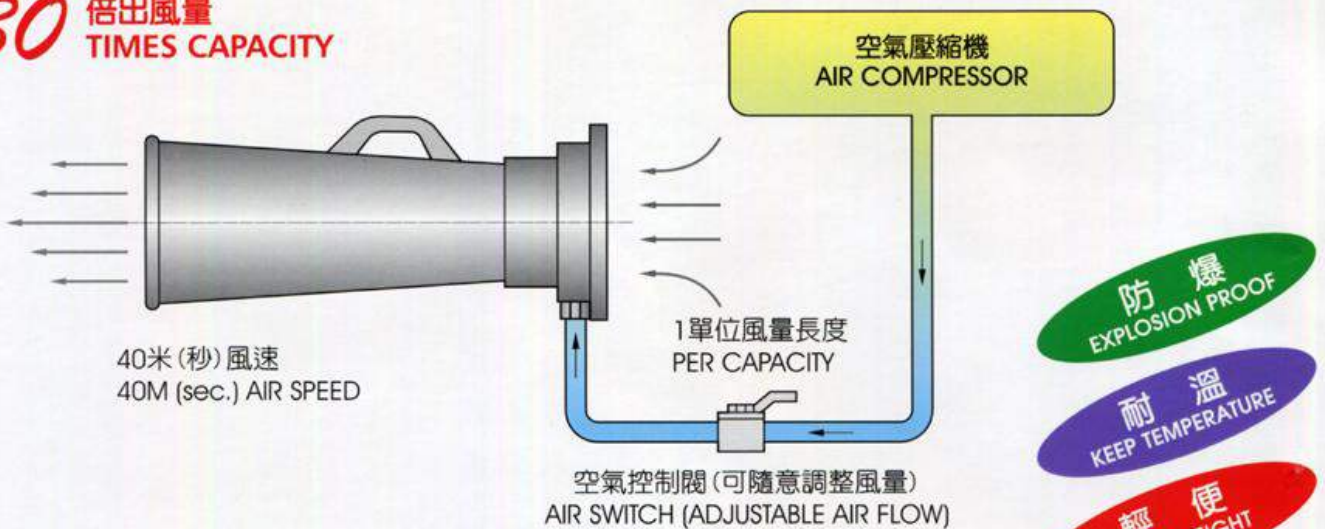

注意事項

- 1 使用前請先清除空氣壓縮機的殘留污水、油垢，以保持其高效率。
- 2 使用時請放置妥當，勿使滾動。
- 3 小心勿吸入碎石及鐵屑，以免發生危險，使用者切勿面對出風口。
- 4 在有瓦斯或易燃氣體之場合，請接地線。

CAUTIONS

- 1 TO HAVE THE BEST PERFORMANCE, PLEASE CLEAN THE SEWAGE AND OIL DUST OF AIR COMPRESSOR BEFORE USING.
- 2 FIX THE JETFLOW AIR MOVERS WITHOUT MOVING.
- 3 BEWARE OF TINY ROCKS OR SCRAPS OF THE WORKING FIELD. DO NOT STAND OR WORK IN FRONT OF OUTPUT OF AIR FLOW
4. PLEASE CONNECT RS WIRE FOR THE FIELDS THAT HAS GAS OR INFLAMMABLE FUME

2S, 3S, 3L (1/2" NPTF)
6L (3/4" NPTF)

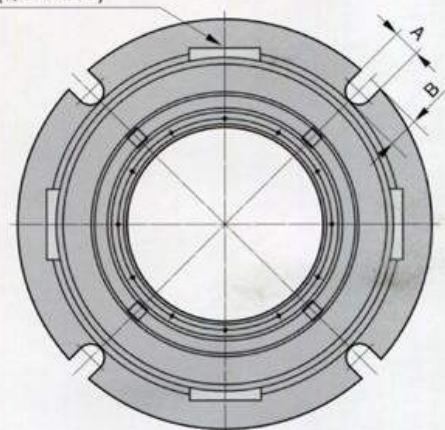

噴氣座
NOZZLE BASE
(材質鋁合金)

型號	尺寸	A	B	溝槽數
2S		11	14	3
3S、3L		13	16.5	4
6L		15	27.4	3

MX-2S

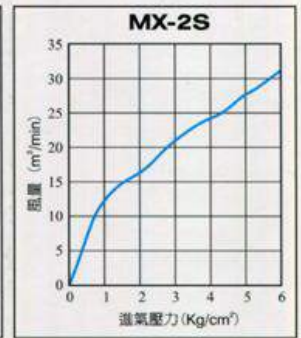
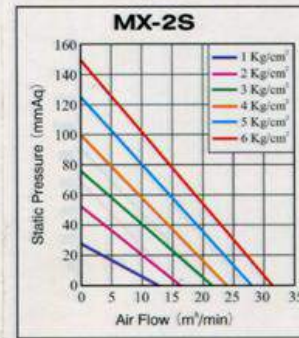
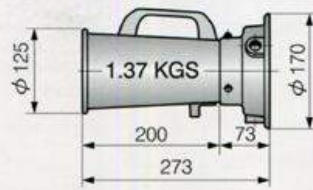

MX-3S

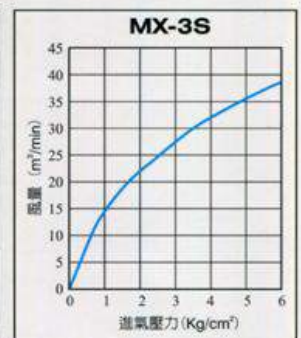
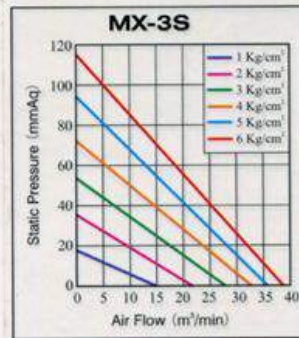
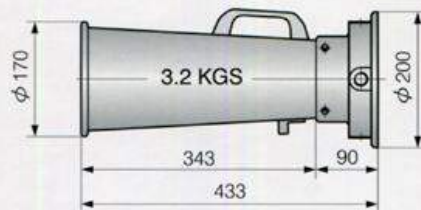

MX-3L

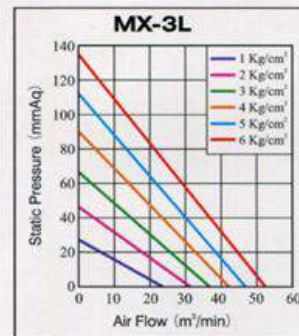
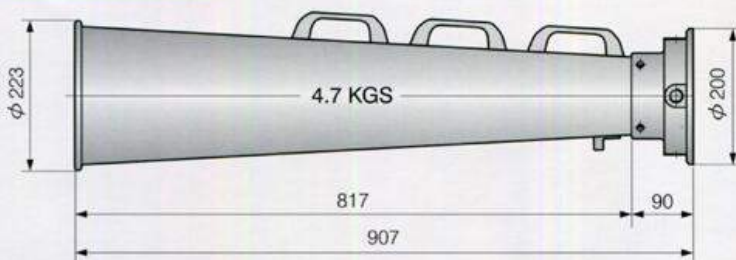

MX-6L

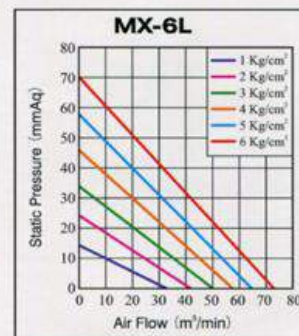
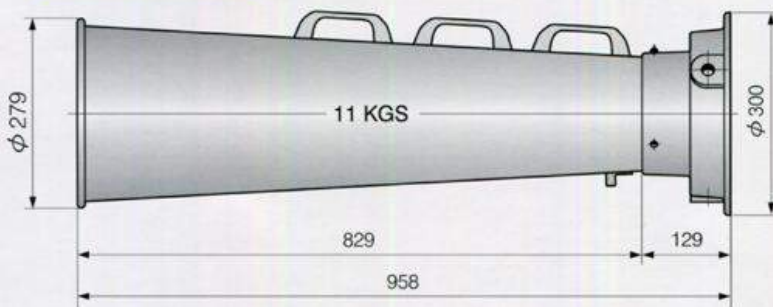

進氣壓力Kg/cm²	1		2		3		4		5		6	
	風量 m³/min	風壓 mmAq	風量 m³/min	風壓 mmAq	風量 m³/min	風壓 mmAq	風量 m³/min	風壓 mmAq	風量 m³/min	風壓 mmAq	風量 m³/min	風壓 mmAq
MX-2S	12.5	28	16.2	52	21	76	24	100	27.5	125	31	150
MX-3S	15	18	22.2	36	27.6	54	32.3	72	35.7	94	38.6	116
MX-3L	24	26	31	46	37	66	42	89	47	112	52	135
MX-6L	34	14	41	24	50	34	58	46	65	58	72	70

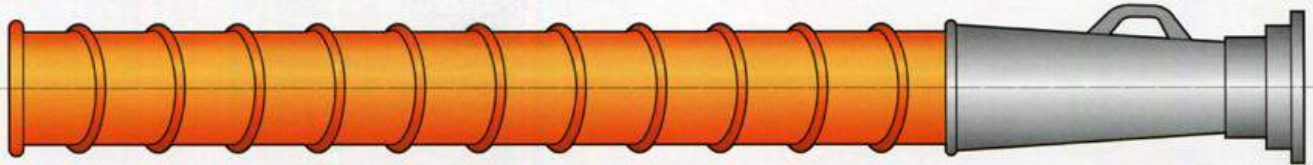

伸縮風管 FLEXIBLE DUCT

噴流式空氣輸送器
JETFLOW AIR MOVER

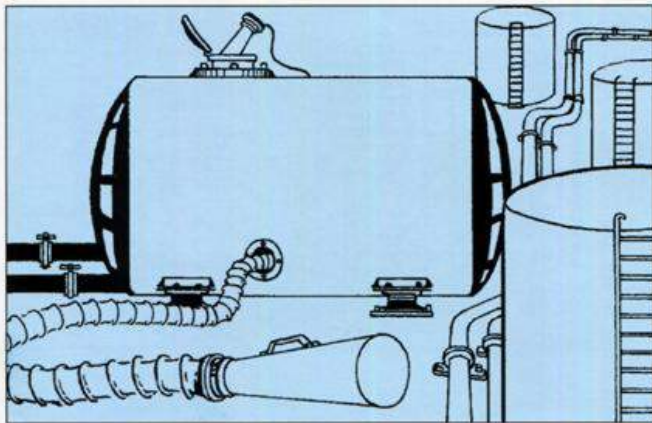

油槽廢氣抽除
VENTILATION FOR EXHAUST GAS OF OIL INSTALLATION



高溫工作環境送風
VENTILATION FOR WORK FIELDS IN HIGH TEMPERATURES

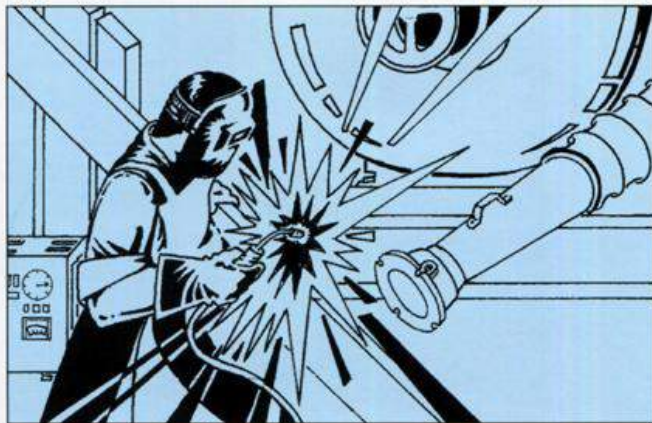

電焊煙塵抽除
DRAFT OF WELDING

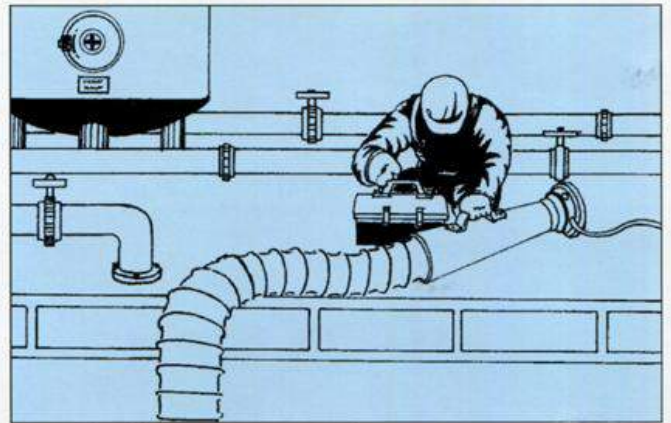

易燃爆之環境抽送風
VENTILATION FOR EXPLOSIVE FIELDS

本公司產品若有規格修改或變更恕不另行通知。
Specifications And Other Descriptions In This Catalog Are Subject to Change Without Notice.